

HOW TO USE PEARL SEQUENCE FOOT

Usable for all models

No. X76670-001

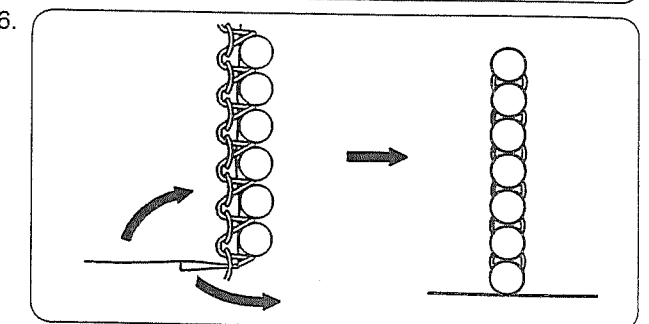
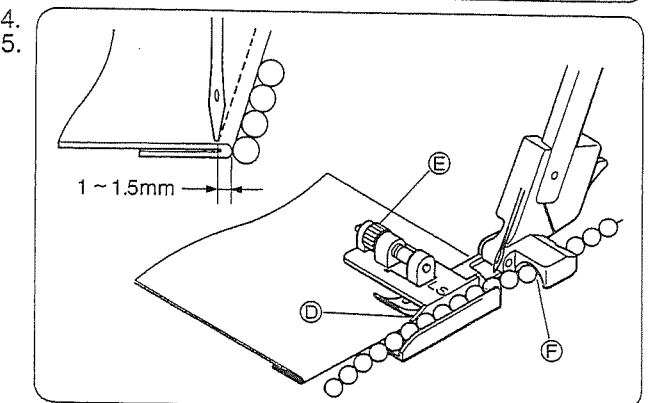
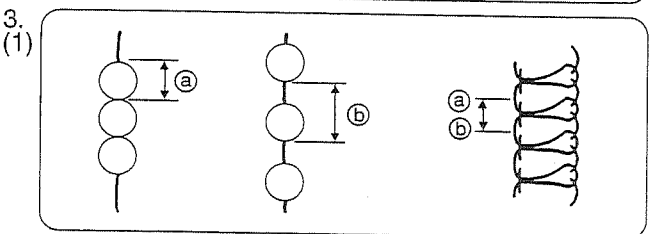
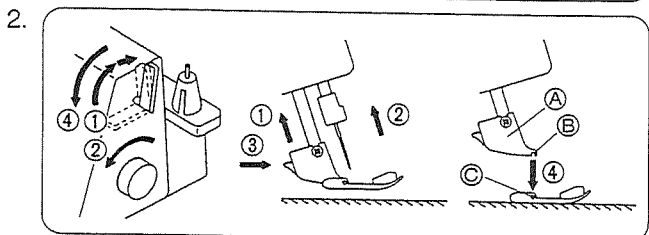
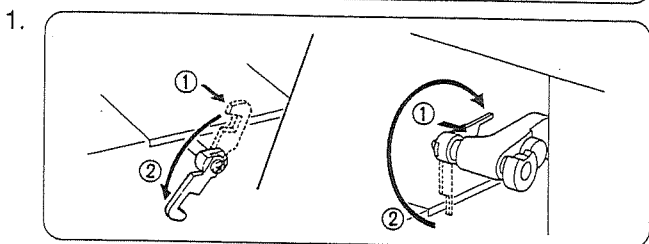
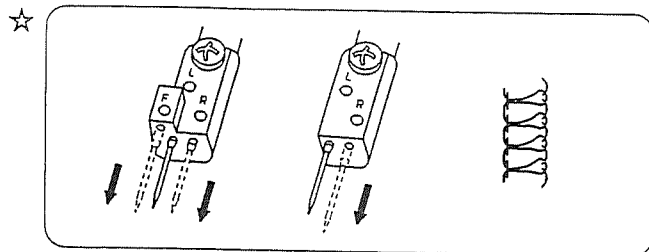
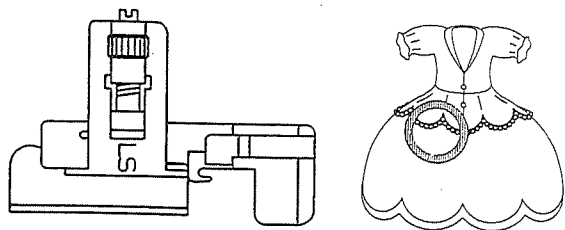

FEATURES

By using the pearl sequence foot, you can bead on fabric. It is useful for decorated edge of curtain, table cloth, dress, etc. From 3 mm to 5 mm sequential pearl can be sewn with this foot.

- ☆ Machine setting (type of stitch)
 - 1 needle 3 thread overlock
 - 1 needle 2 thread overlock
- ※ In case of 2 needle type machine, use left needle only.
- ※ This foot can not be used with double chain stitch. In case that needle for double chain stitch is fit, also remove it.

1. HOW TO SET THE FOOT

Turn off the main power switch or disconnect the electric supply plug to avoid any possible hazards. And open front cover and retract blade. (refer to instruction for blade retraction)

2. SET THE FOOT

- (1) Raise the presser foot lever.
- (2) Set the needle to its highest position by turning the hand wheel.
- (3) Push the button of the presser foot holder and the standard foot will be disengaged as illustrated.
- (4) Place the pearl sequence foot just under the presser foot holder (A) so that the groove (B) of presser foot holder catch pin (C) of the foot when lower the presser foot lever.

3. HOW TO ADJUST THE MACHINE

- (1) Adjust stitch length according to the length as illustrated ① or ②. For example, 4 mm stitch length means 4 mm for ① or ②.
- (2) Adjust stitch width 3 to 5 mm.
- (3) Adjust thread tension as follows,

	3 thread	4 thread
Needle thread	slightly decrease	slightly increase
Overlooper thread	slightly decrease	—
Underlooper thread	slightly increase	slightly decrease

※ refer to instruction manual for adjusting thread tension.

4. HOW TO SET FABRIC

- (1) Fold the fabric according to the line for pearl fitting.
- (2) Place the fabric at needle dropping point with keeping the folded edge with guide (D).
- (3) Adjust the guide the clearance between folded edge and needle 1 mm to 1.5 mm by adjusting screw (E).

5. HOW TO SET PEARL

Place the pearl through the guide but just front of guide tunnel (F).

6. TRIAL SEWING

- (1) Sew turning handwheel by hand until the pearl coming through the tunnel.
- (2) Sew with slow speed with keeping the pearl and fabric by hand.
- (3) Tie both end of thread at the beginning and end to avoid removing pearl.

NOTE!

Thread tension is easy to loosen especially for small size pearl. So you should retract movable stitch tongue for better stitching.