

HOW TO USE THE BLIND STITCHING WITH MULTI PURPOSE FOOT

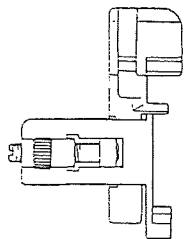

FEATURES

1. When using this blind stitch presser foot (multi purpose foot), you can sew blind stitches and overlock at the same time ideal when sewing cuffs, trouser, bottoms, pockets etc.
2. The stitch guide on this foot is all so useful when sewing e.g. flat lock stitching, pintuckstitching, decorative stitching etc.
3. This stitchguide is easily adjustable without using any tools.

1. BLIND STITCHING

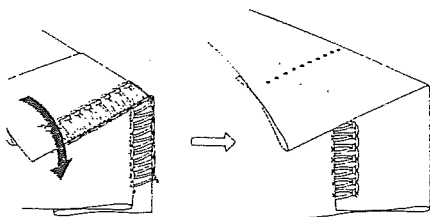
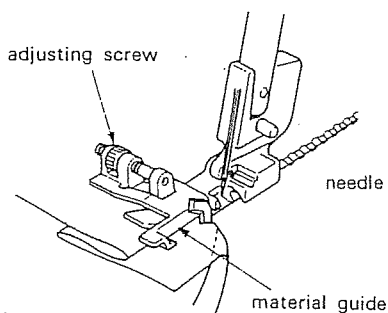
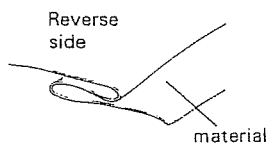
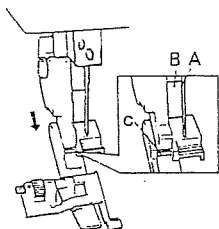
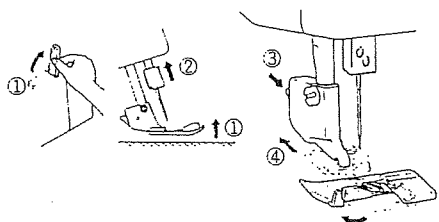

TO FIX THE MULTI PURPOSE FOOT

※ Set up the machine for 1.needle 3.thread overlock in case of 2.needle 4. thread type machine use left needle only.

1. Raise the presser foot lever.
2. Set the needle to its highest position by turning the handle wheel.
3. Push the button of the presser foot holder and the standard foot will be released.
4. Raise the presser foot farther by pushing the presser foot lever upward then remove the presser foot.
5. Raise the presser foot farther by pushing the presser foot lever upward then place the blind stitch presser foot (multi purpose foot) just under the presser foot holder (A) so that the groove (B) of the presser foot holder catch pin and the bar of the foot (C) are aligned then lower the presser foot lever.

TEST SEW ON A SCRAP OF FABRIC FIRST AND ADJUST THE STITCH GUIDE AND THREAD TENSION

1. Turn the wrong side of the fabric out fold the fabric once and then back to the required width as illustrated.
- ※ Swing will be easier if a creast is ironed in to the folded material before sewing.
2. Turn the hand wheel by hand and set the needle at its highest position.
 3. Lift the presser foot lever and insert the fabric with the folded edge, in such a way that the needle pierces just the folded edge.
 4. Lower the presser foot lever adjust the stitch guide toward the folded edge.
 5. Adjust the guide position of the presser foot with adjusting screw so that the needle is lightly touching the creast in the material, in this case the thickness of the material is the criterion. By turning the screw forward (toward you) the stitch guide will go to the right. By turning the screw backward (a way from you) the stitch guide will go to the left.
 6. While folding the material by hand sew so that the needle just catches the edge of the creast.
 7. Open the material as shown in the illustration.
- ※ To adjust the position of the material guide the same piece of material can be used to make a test sewing.
- ※ An attractive finish can be obtained by using a thread that is the same colors as the material and which is as fine as possible.

2. FLAT OVERLOCK STITCHING

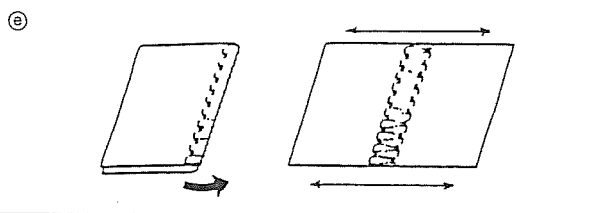
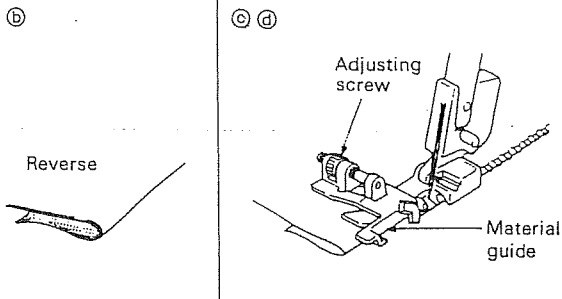
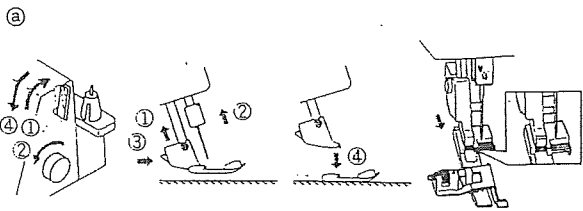

- Ⓐ Replace the presser foot with a blind presser foot.
- Ⓑ Fold the material in two as shown in the illustration. Then raise the presser foot, set the material so that it is below the needle, and then lower the presser foot.
- ※ Set the stitch width control dial to "7"
- Ⓒ Adjust with the adjusting screw so that the needle moves down to a position 2.5—3.0 mm (0.1—0.12 in.) inside the folded edge of the material.
- Ⓓ While guiding the material with your hand, sew at a constant speed.
- Ⓔ Open up the material as shown in the illustration.
- ※ This method is not suitable for thin materials.
- ※ To adjust the position of the material guide, the same piece of material can be used to make a test sewing.

3. PIN TUCK STITCHING

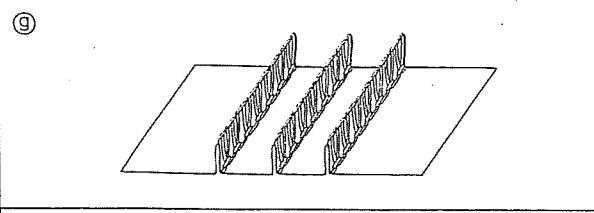
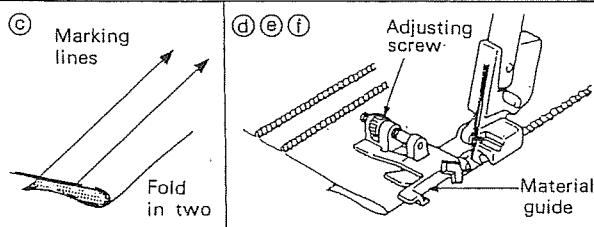
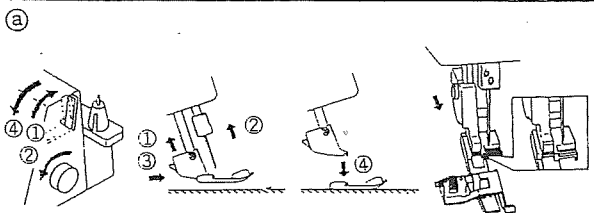

- Use the blind presser foot guide and make narrow hemming stitches to produce seams in the form of ridges at equal distances from each other.
- For thin materials, it's a good idea to choose a fine thread which runs smoothly.
- Ⓐ Replace the presser foot with a blind presser foot.
 - Ⓑ Set up the machine for narrow overlock stitching. (Refer to pages 40—41.)
 - Ⓒ First, draw regular-spaced marking lines on the material as guides for pin tucking.
 - Ⓓ Adjust so that the guide of the blind presser foot is aligned with the line on the right of the stitch tongue.
 - Ⓔ Align the crease with the guide and insert the material as far as the needle position.
 - Ⓕ Sew along the marking lines which were made on the material while guiding the material.
 - Ⓖ Continue sewing until all marking lines have been sewn.
 - ※ Correct minor contractions by hand.

4. DECORATIVE STITCHING

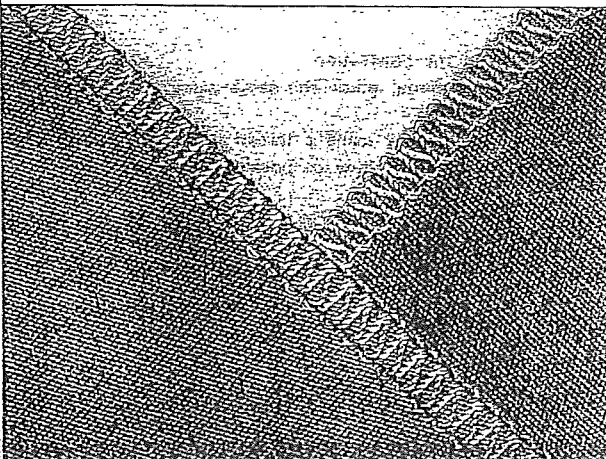

Attractive decorative stitches can be made through different combinations of material and thread. Decorative thread with a high thread count or extremely fine thread can be used as the overlocker thread to produce decorative stitching with an even stitch length.