

Design:Space 01.EMB

Height: 95.1 mm
 Width: 85.6 mm
 Stitches: 13,819
 Colors: 7
 Color changes: 10
 Trims: 30
 Hoop: No hoop
 Total bobbin: 28.18m

Color Sequence:

#	Color	Code	Name	Chart
1.	1	1000	Classic Black	Hemingworth PolySelect
2.	2	1076	Nautical Blue	Hemingworth PolySelect
3.	3	1075	Misty Blue Gray	Hemingworth PolySelect
4.	2	1076	Nautical Blue	Hemingworth PolySelect
5.	4	1001	Pure White	Hemingworth PolySelect
6.	5	1023	Marigold	Hemingworth PolySelect
7.	1	1000	Classic Black	Hemingworth PolySelect
8.	5	1023	Marigold	Hemingworth PolySelect
9.	1	1000	Classic Black	Hemingworth PolySelect
10.	6	1021	Whipped Papaya	Hemingworth PolySelect
11.	7	1278	Rebel Peach	Hemingworth PolySelect

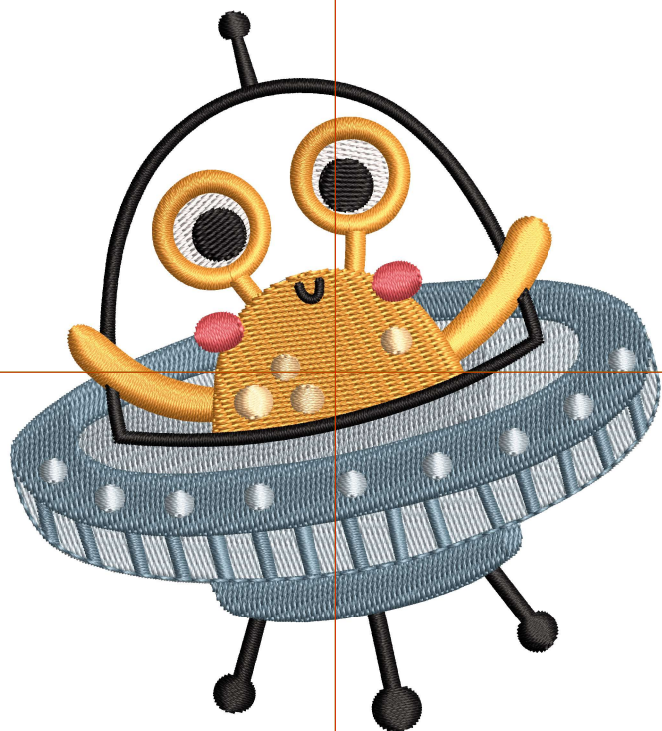

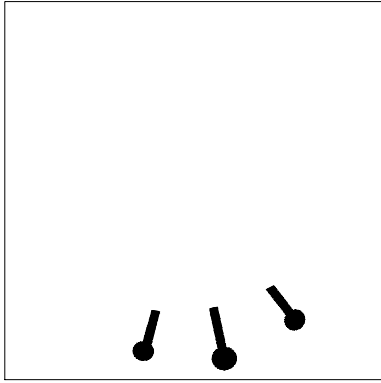

Color: 1
Stop: 1
Element:
Code: 1000
Name: Classic Black
Chart: Hemingworth PolySelect
Stitches: 491
Thread used: 2.58m

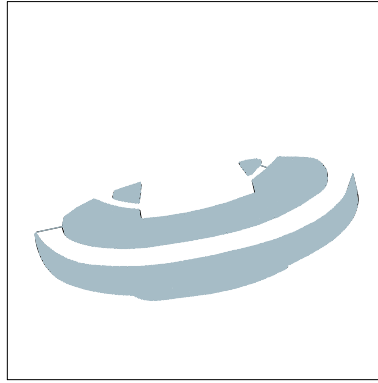

Color: 2
Stop: 2
Element:
Code: 1076
Name: Nautical Blue
Chart: Hemingworth PolySelect
Stitches: 3,715
Thread used: 20.81m

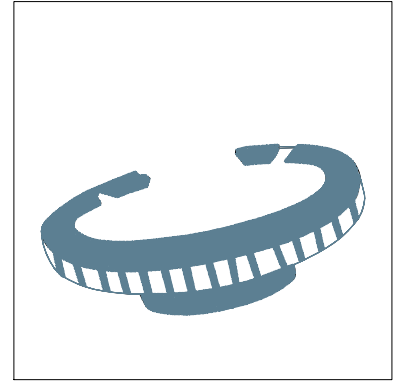

Color: 3
Stop: 3
Element:
Code: 1075
Name: Misty Blue Gray
Chart: Hemingworth PolySelect
Stitches: 4,424
Thread used: 23.13m

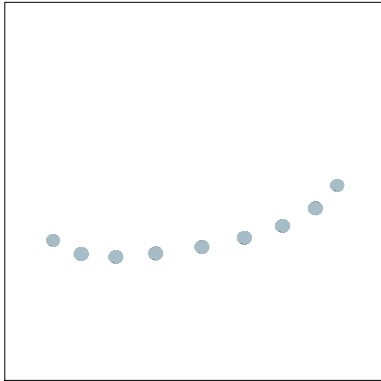

Color: 2
Stop: 4
Element:
Code: 1076
Name: Nautical Blue
Chart: Hemingworth PolySelect
Stitches: 345
Thread used: 1.63m

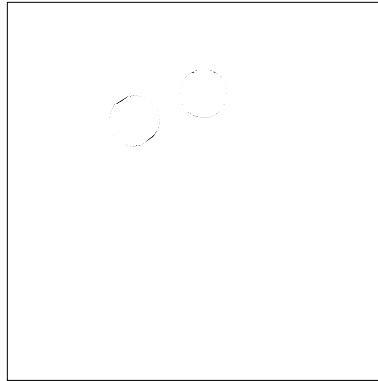

Color: 4
Stop: 5
Element:
Code: 1001
Name: Pure White
Chart: Hemingworth PolySelect
Stitches: 710
Thread used: 3.93m

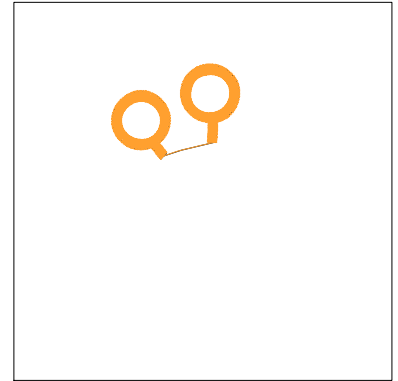

Color: 5
Stop: 6
Element:
Code: 1023
Name: Marigold
Chart: Hemingworth PolySelect
Stitches: 655
Thread used: 3.62m

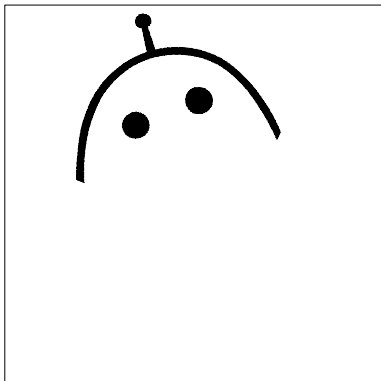

Color: 1
Stop: 7
Element:
Code: 1000
Name: Classic Black
Chart: Hemingworth PolySelect
Stitches: 1,009
Thread used: 4.78m

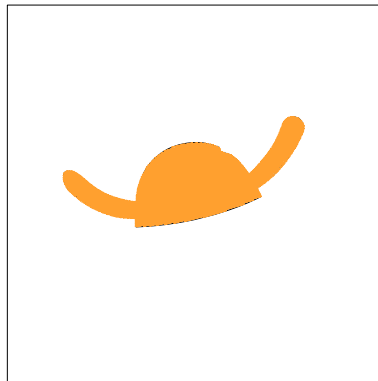

Color: 5
Stop: 8
Element:
Code: 1023
Name: Marigold
Chart: Hemingworth PolySelect
Stitches: 1,532
Thread used: 10.32m

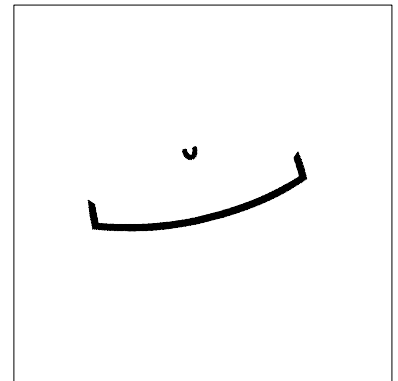

Color: 1
Stop: 9
Element:
Code: 1000
Name: Classic Black
Chart: Hemingworth PolySelect
Stitches: 551
Thread used: 2.39m

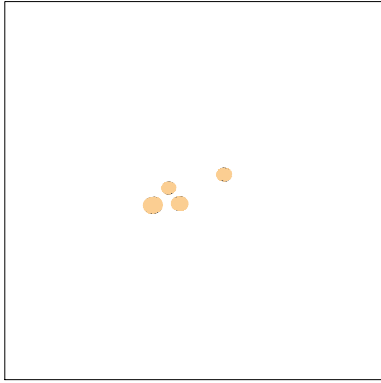

Color: 6
Stop: 10
Element:
Code: 1021
Name: Whipped Papaya
Chart: Hemingworth PolySelect
Stitches: 206
Thread used: 1.02m

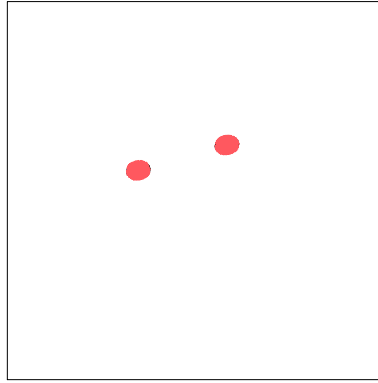

Color: 7
Stop: 11
Element:
Code: 1278
Name: Rebel Peach
Chart: Hemingworth PolySelect
Stitches: 181
Thread used: 1.00m

Design:Space 02.EMB

Height: 95.6 mm
 Width: 64.7 mm
 Stitches: 9,272
 Colors: 6
 Color changes: 8
 Trims: 16
 Hoop: No hoop
 Total bobbin: 20.17m

Color Sequence:

#	Color	Code	Name	Chart
1.	1	1023	Marigold	Hemingworth PolySelect
2.	2	1021	Whipped Papaya	Hemingworth PolySelect
3.	1	1023	Marigold	Hemingworth PolySelect
4.	3	1076	Nautical Blue	Hemingworth PolySelect
5.	4	1075	Misty Blue Gray	Hemingworth PolySelect
6.	3	1076	Nautical Blue	Hemingworth PolySelect
7.	5	1001	Pure White	Hemingworth PolySelect
8.	1	1023	Marigold	Hemingworth PolySelect
9.	6	1000	Classic Black	Hemingworth PolySelect

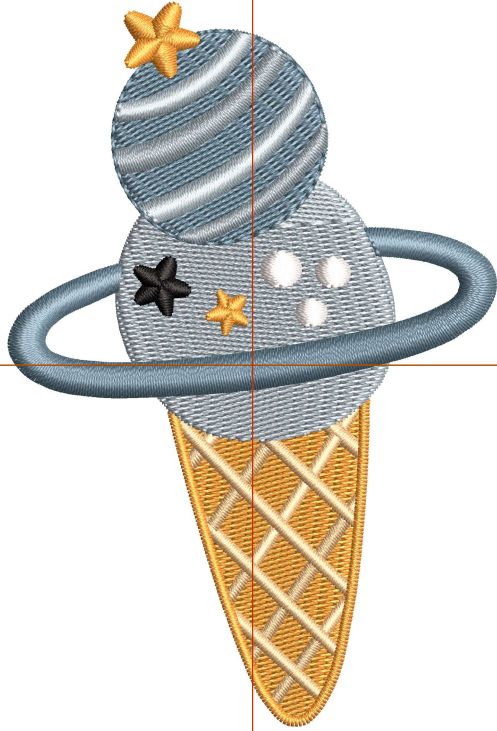

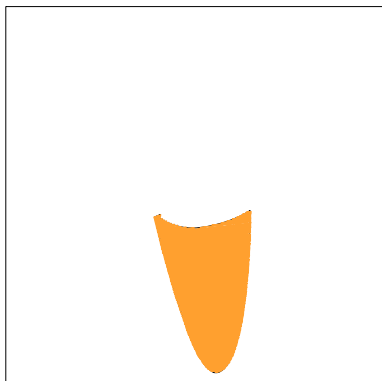

Color: 1
Stop: 1
Element:
Code: 1023
Name: Marigold
Chart: Hemingworth PolySelect
Stitches: 1,527
Thread used: 9.42m

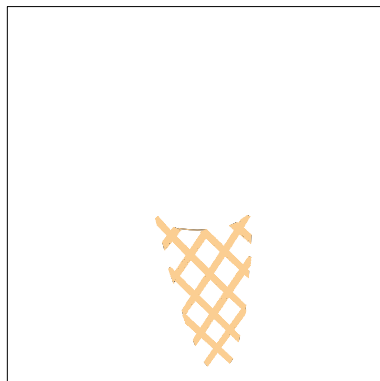

Color: 2
Stop: 2
Element:
Code: 1021
Name: Whipped Papaya
Chart: Hemingworth PolySelect
Stitches: 1,357
Thread used: 5.81m



Color: 1
Stop: 3
Element:
Code: 1023
Name: Marigold
Chart: Hemingworth PolySelect
Stitches: 610
Thread used: 2.19m

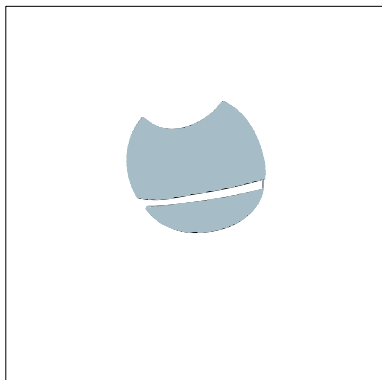

Color: 3
Stop: 4
Element:
Code: 1076
Name: Nautical Blue
Chart: Hemingworth PolySelect
Stitches: 1,842
Thread used: 11.70m

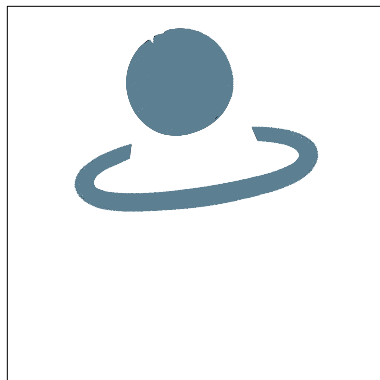

Color: 4
Stop: 5
Element:
Code: 1075
Name: Misty Blue Gray
Chart: Hemingworth PolySelect
Stitches: 2,358
Thread used: 15.72m

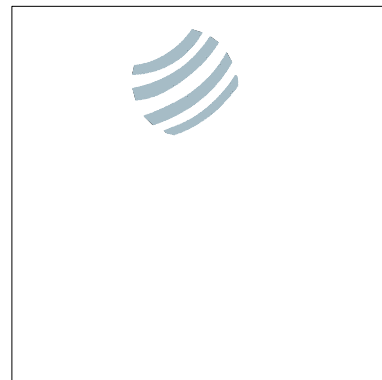

Color: 3
Stop: 6
Element:
Code: 1076
Name: Nautical Blue
Chart: Hemingworth PolySelect
Stitches: 738
Thread used: 4.01m

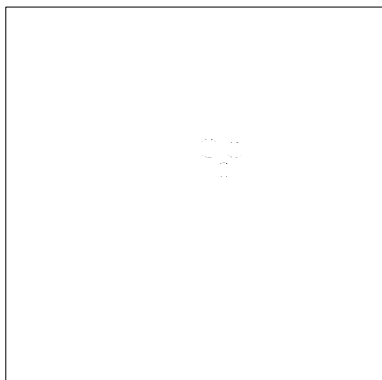

Color: 5
Stop: 7
Element:
Code: 1001
Name: Pure White
Chart: Hemingworth PolySelect
Stitches: 203
Thread used: 1.00m

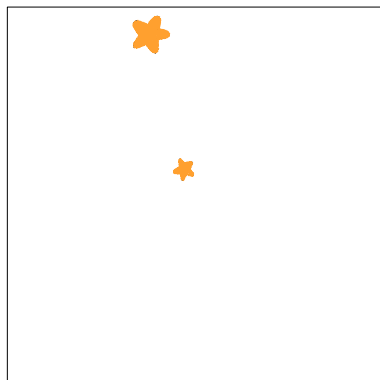

Color: 1
Stop: 8
Element:
Code: 1023
Name: Marigold
Chart: Hemingworth PolySelect
Stitches: 460
Thread used: 1.96m

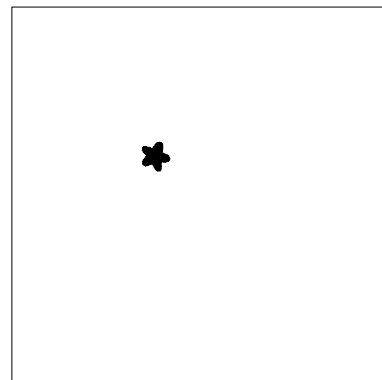

Color: 6
Stop: 9
Element:
Code: 1000
Name: Classic Black
Chart: Hemingworth PolySelect
Stitches: 177
Thread used: 0.77m

Design:Space 03.EMB

Height: 95.6 mm
Width: 96.2 mm
Stitches: 16,422
Colors: 4
Color changes: 3
Trims: 13
Hoop: No hoop
Total bobbin: 39.40m

Color Sequence:

#	Color	Code	Name	Chart
1.	1	1021	Whipped Papaya	Hemingworth PolySelect
2.	2	1023	Marigold	Hemingworth PolySelect
3.	3	1000	Classic Black	Hemingworth PolySelect
4.	4	1014	Carnation	Hemingworth PolySelect

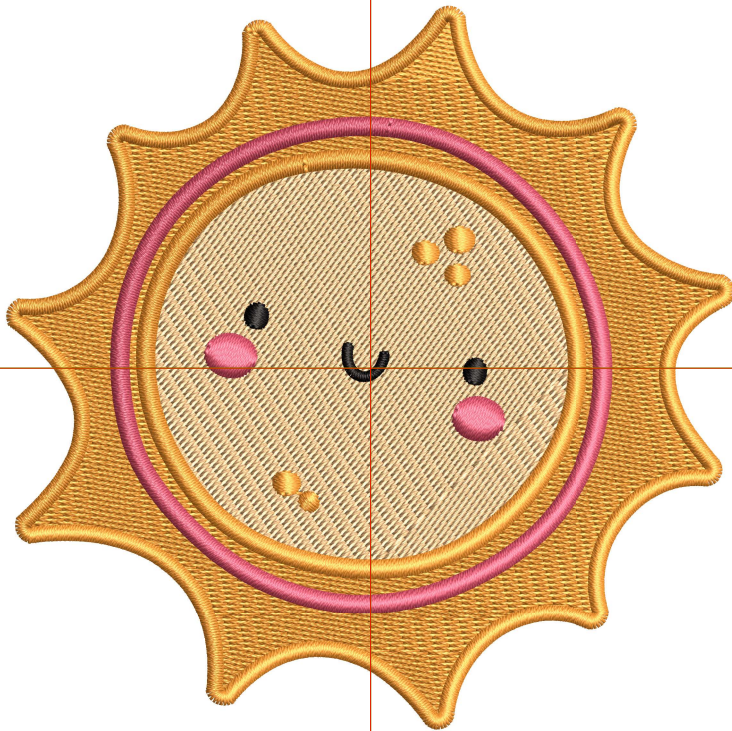

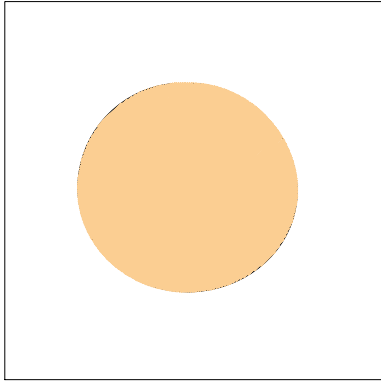

Color: 1
Stop: 1
Element:
Code: 1021
Name: Whipped Papaya
Chart: Hemingworth PolySelect
Stitches: 4,691
Thread used: 32.28m

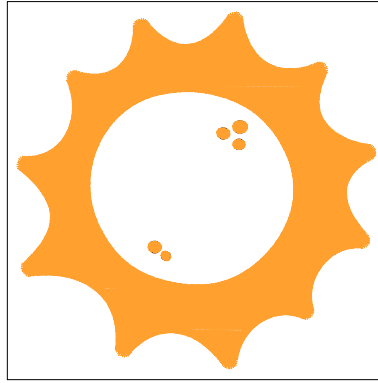

Color: 2
Stop: 2
Element:
Code: 1023
Name: Marigold
Chart: Hemingworth PolySelect
Stitches: 10,077
Thread used: 58.38m



Color: 3
Stop: 3
Element:
Code: 1000
Name: Classic Black
Chart: Hemingworth PolySelect
Stitches: 169
Thread used: 0.67m

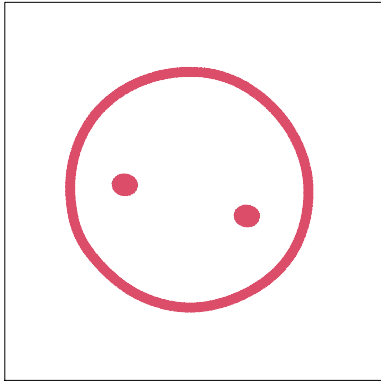

Color: 4
Stop: 4
Element:
Code: 1014
Name: Carnation
Chart: Hemingworth PolySelect
Stitches: 1,485
Thread used: 8.00m

Design:Space 04.EMB

Height: 97.5 mm
Width: 94.6 mm
Stitches: 19,256
Colors: 4
Color changes: 3
Trims: 7
Hoop: No hoop
Total bobbin: 48.26m

Color Sequence:

#	Color	Code	Name	Chart
1.	1	H-025-1118	Marshmallow	Hemingworth
2.	2	H-020-1077	Antique Silver	Hemingworth
3.	3	H-222-1018	Dark Salmon	Hemingworth
4.	4	H-024-1000	Classic Black	Hemingworth

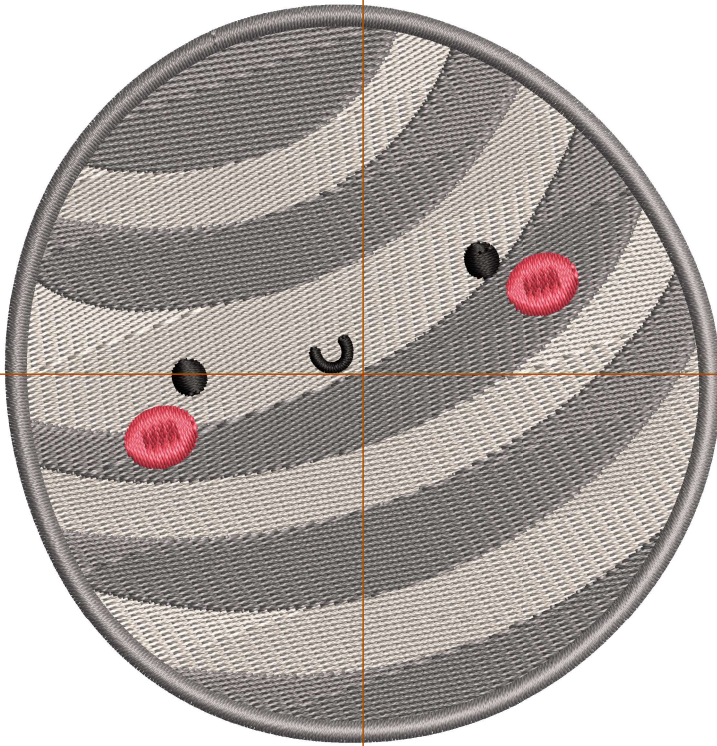

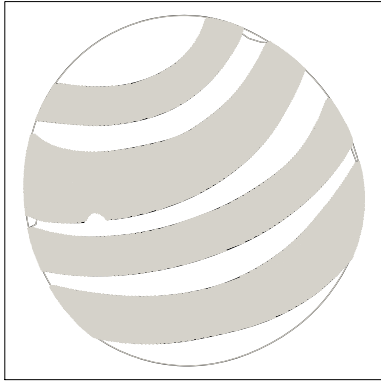

Color: 1
Stop: 1
Element:
Code: H-025-1118
Name: Marshmallow
Chart: Hemingworth
Stitches: 9,062
Thread used: 58.79m



Color: 2
Stop: 2
Element:
Code: H-020-1077
Name: Antique Silver
Chart: Hemingworth
Stitches: 9,713
Thread used: 58.54m

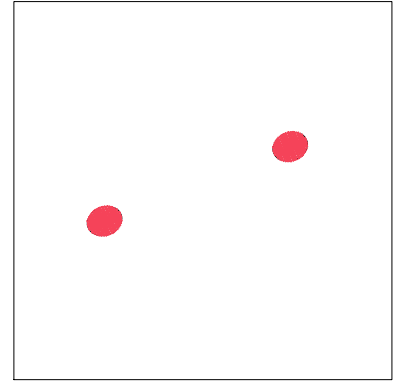

Color: 3
Stop: 3
Element:
Code: H-222-1018
Name: Dark Salmon
Chart: Hemingworth
Stitches: 273
Thread used: 1.64m

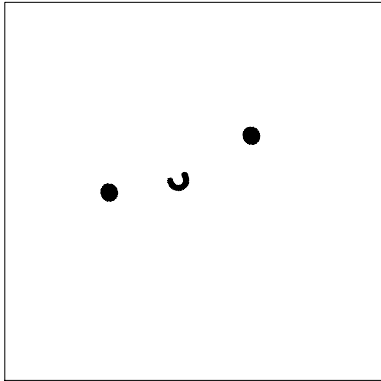

Color: 4
Stop: 4
Element:
Code: H-024-1000
Name: Classic Black
Chart: Hemingworth
Stitches: 208
Thread used: 0.97m

Design:Space 05.EMB

Height: 95.6 mm
Width: 92.0 mm
Stitches: 11,770
Colors: 3
Color changes: 2
Trims: 10
Hoop: No hoop
Total bobbin: 29.05m

Color Sequence:

#	Color	Code	Name	Chart
1.	1	1000	Classic Black	Hemingworth PolySelect
2.	2	1023	Marigold	Hemingworth PolySelect
3.	3	1021	Whipped Papaya	Hemingworth PolySelect

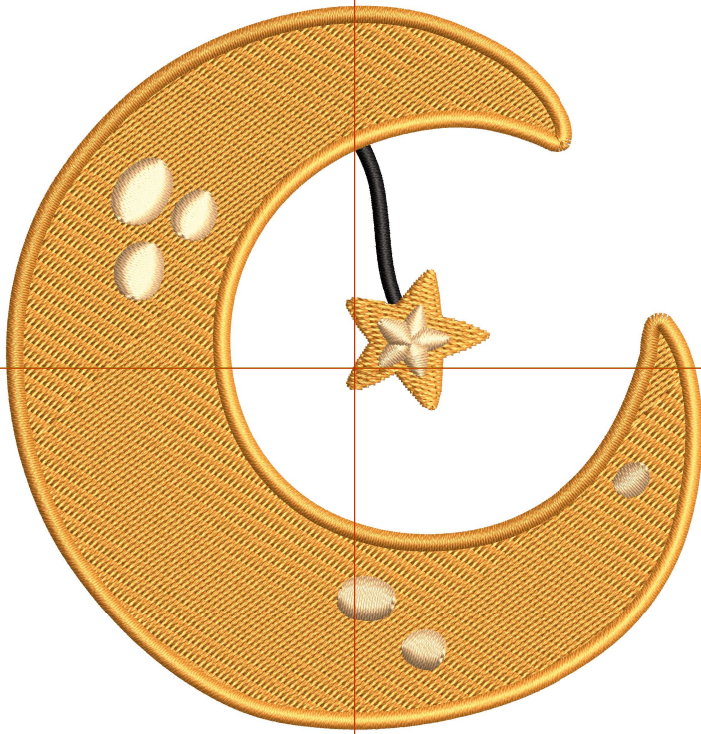

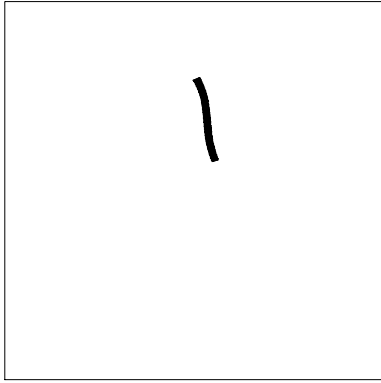

Color: 1
Stop: 1
Element:
Code: 1000
Name: Classic Black
Chart: Hemingworth PolySelect
Stitches: 169
Thread used: 0.77m

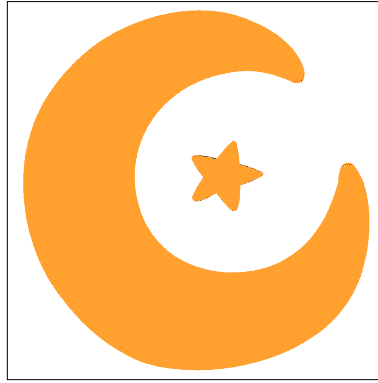

Color: 2
Stop: 2
Element:
Code: 1023
Name: Marigold
Chart: Hemingworth PolySelect
Stitches: 10,791
Thread used: 67.24m

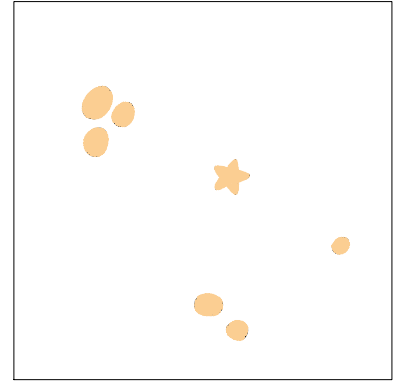

Color: 3
Stop: 3
Element:
Code: 1021
Name: Whipped Papaya
Chart: Hemingworth PolySelect
Stitches: 810
Thread used: 4.55m

Design:Space 06.EMB

Height: 95.1 mm
 Width: 64.6 mm
 Stitches: 10,515
 Colors: 8
 Color changes: 9
 Trims: 33
 Hoop: No hoop
 Total bobbin: 23.04m

Color Sequence:

#	Color	Code	Name	Chart
1.	1	1118	Marshmallow	Hemingworth PolySelect
2.	2	1077	Antique Silver	Hemingworth PolySelect
3.	3	1001	Pure White	Hemingworth PolySelect
4.	4	1075	Misty Blue Gray	Hemingworth PolySelect
5.	5	1076	Nautical Blue	Hemingworth PolySelect
6.	4	1075	Misty Blue Gray	Hemingworth PolySelect
7.	5	1076	Nautical Blue	Hemingworth PolySelect
8.	6	1278	Rebel Peach	Hemingworth PolySelect
9.	7	1023	Marigold	Hemingworth PolySelect
10.	8	1000	Classic Black	Hemingworth PolySelect

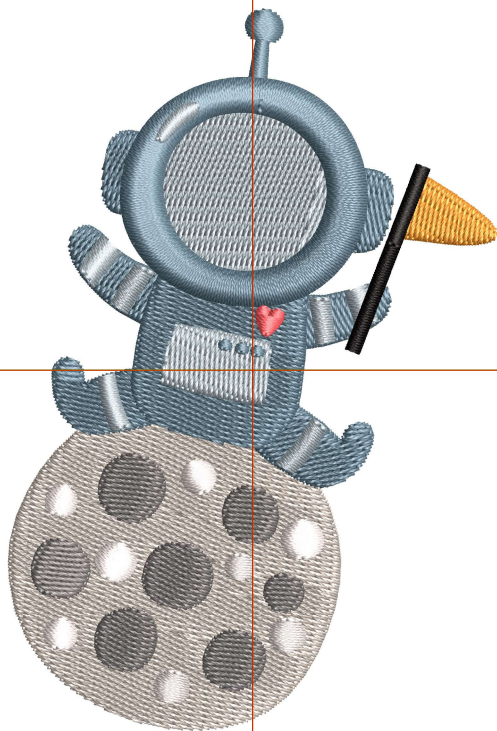

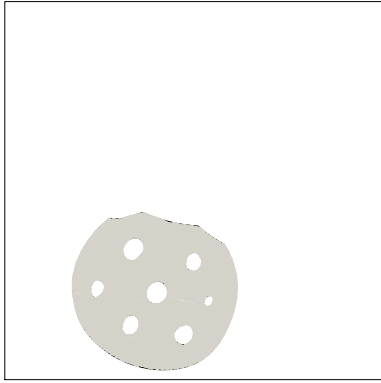

Color: 1
Stop: 1
Element:
Code: 1118
Name: Marshmallow
Chart: Hemingworth PolySelect
Stitches: 3,113
Thread used: 18.61m

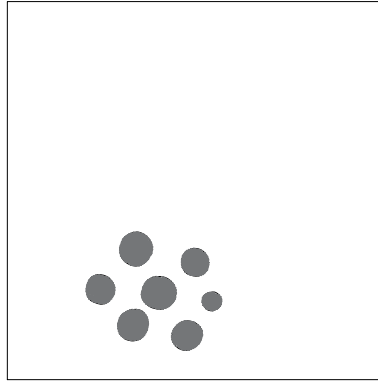

Color: 2
Stop: 2
Element:
Code: 1077
Name: Antique Silver
Chart: Hemingworth PolySelect
Stitches: 1,187
Thread used: 5.74m

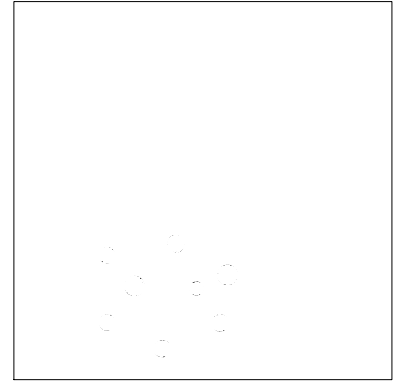

Color: 3
Stop: 3
Element:
Code: 1001
Name: Pure White
Chart: Hemingworth PolySelect
Stitches: 532
Thread used: 2.68m

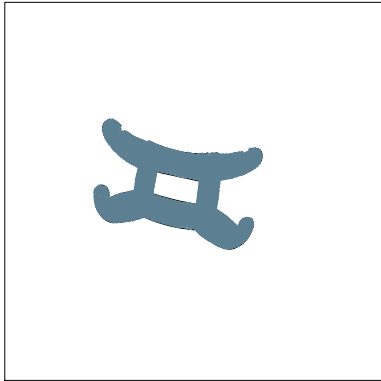

Color: 4
Stop: 4
Element:
Code: 1075
Name: Misty Blue Gray
Chart: Hemingworth PolySelect
Stitches: 2,022
Thread used: 10.87m

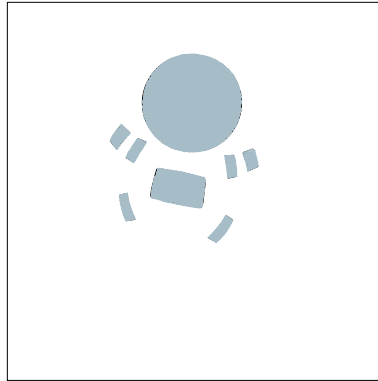

Color: 5
Stop: 5
Element:
Code: 1076
Name: Nautical Blue
Chart: Hemingworth PolySelect
Stitches: 1,764
Thread used: 10.48m

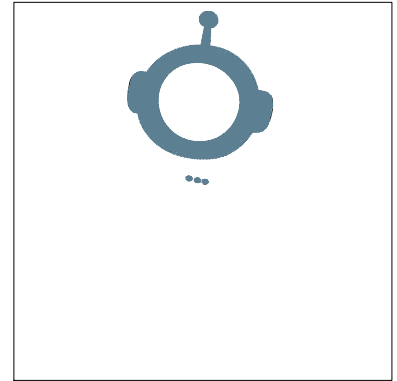

Color: 4
Stop: 6
Element:
Code: 1075
Name: Misty Blue Gray
Chart: Hemingworth PolySelect
Stitches: 1,340
Thread used: 8.91m

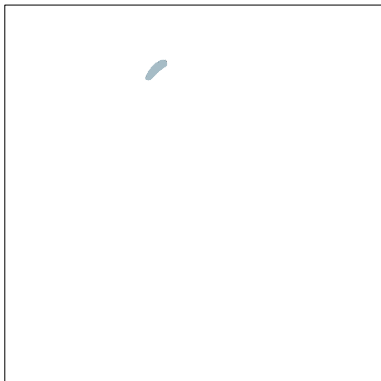

Color: 5
Stop: 7
Element:
Code: 1076
Name: Nautical Blue
Chart: Hemingworth PolySelect
Stitches: 65
Thread used: 0.27m

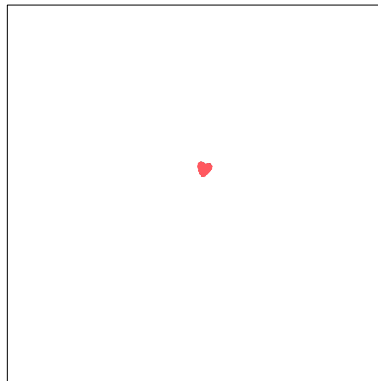

Color: 6
Stop: 8
Element:
Code: 1278
Name: Rebel Peach
Chart: Hemingworth PolySelect
Stitches: 59
Thread used: 0.25m

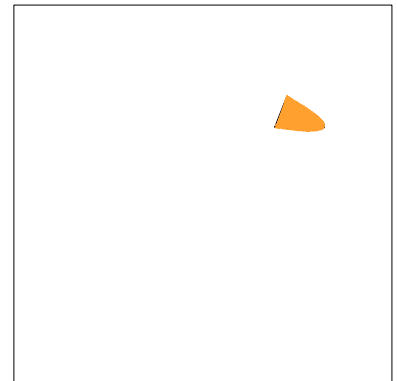

Color: 7
Stop: 9
Element:
Code: 1023
Name: Marigold
Chart: Hemingworth PolySelect
Stitches: 238
Thread used: 1.19m

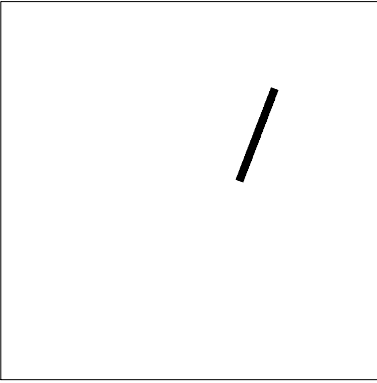

Color: 8
Stop: 10
Element:
Code: 1000
Name: Classic Black
Chart: Hemingworth PolySelect
Stitches: 195
Thread used: 0.90m

Design:Space 07.EMB

Height: 77.4 mm
Width: 95.6 mm
Stitches: 7,774
Colors: 4
Color changes: 3
Trims: 11
Hoop: No hoop
Total bobbin: 15.19m

Color Sequence:

#	Color	Code	Name	Chart
1.	1	1000	Classic Black	Hemingworth PolySelect
2.	2	1076	Nautical Blue	Hemingworth PolySelect
3.	3	1075	Misty Blue Gray	Hemingworth PolySelect
4.	4	1001	Pure White	Hemingworth PolySelect

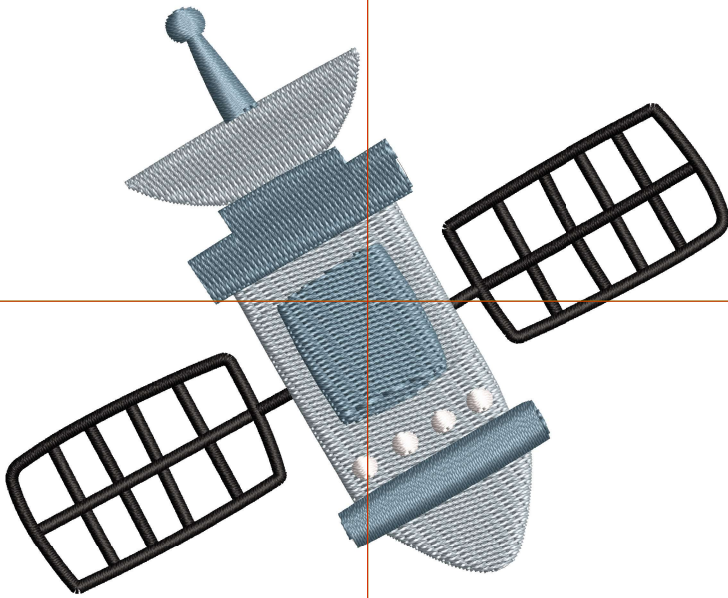

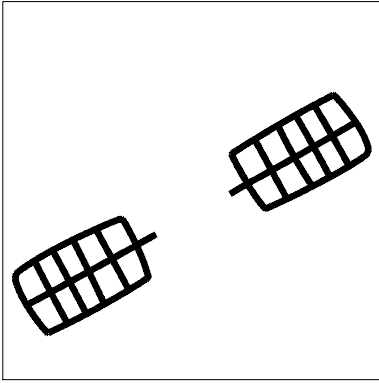

Color: 1
Stop: 1
Element:
Code: 1000
Name: Classic Black
Chart: Hemingworth PolySelect
Stitches: 2,943
Thread used: 12.47m

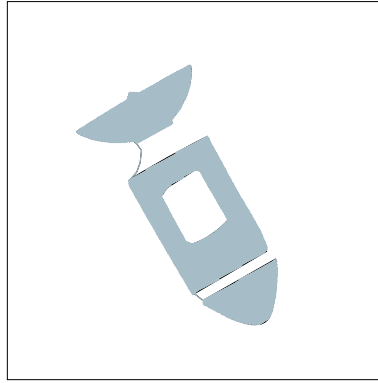

Color: 2
Stop: 2
Element:
Code: 1076
Name: Nautical Blue
Chart: Hemingworth PolySelect
Stitches: 2,763
Thread used: 16.12m



Color: 3
Stop: 3
Element:
Code: 1075
Name: Misty Blue Gray
Chart: Hemingworth PolySelect
Stitches: 1,929
Thread used: 11.98m

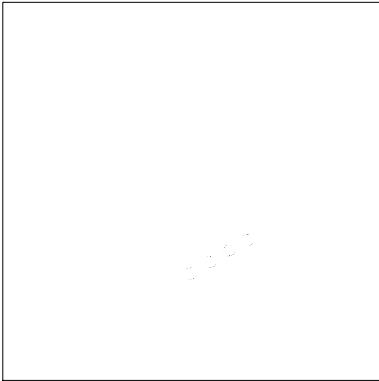

Color: 4
Stop: 4
Element:
Code: 1001
Name: Pure White
Chart: Hemingworth PolySelect
Stitches: 139
Thread used: 0.62m

Design:Space 08.EMB

Height: 95.6 mm
 Width: 80.8 mm
 Stitches: 15,099
 Colors: 6
 Color changes: 11
 Trims: 26
 Hoop: No hoop
 Total bobbin: 33.88m

Color Sequence:

#	Color	Code	Name	Chart
1.	1	1000	Classic Black	Hemingworth PolySelect
2.	2	1076	Nautical Blue	Hemingworth PolySelect
3.	3	1118	Marshmallow	Hemingworth PolySelect
4.	4	1001	Pure White	Hemingworth PolySelect
5.	5	1075	Misty Blue Gray	Hemingworth PolySelect
6.	1	1000	Classic Black	Hemingworth PolySelect
7.	5	1075	Misty Blue Gray	Hemingworth PolySelect
8.	1	1000	Classic Black	Hemingworth PolySelect
9.	4	1001	Pure White	Hemingworth PolySelect
10.	3	1118	Marshmallow	Hemingworth PolySelect
11.	6	1278	Rebel Peach	Hemingworth PolySelect
12.	1	1000	Classic Black	Hemingworth PolySelect

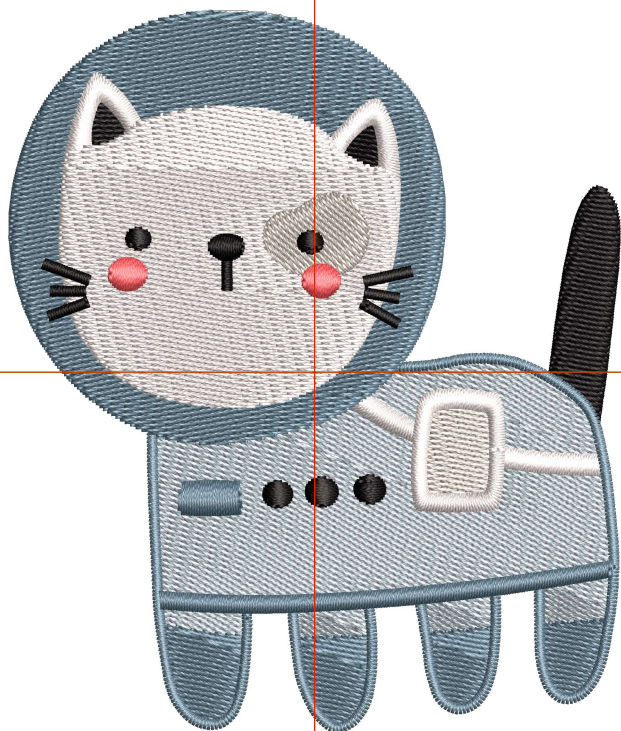

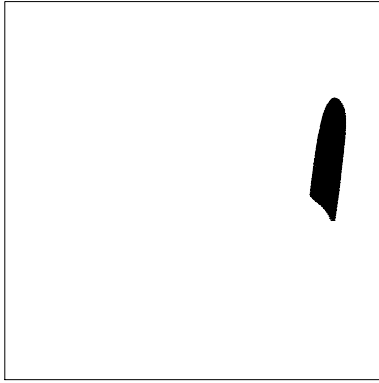

Color: 1
Stop: 1
Element:
Code: 1000
Name: Classic Black
Chart: Hemingworth PolySelect
Stitches: 567
Thread used: 2.96m

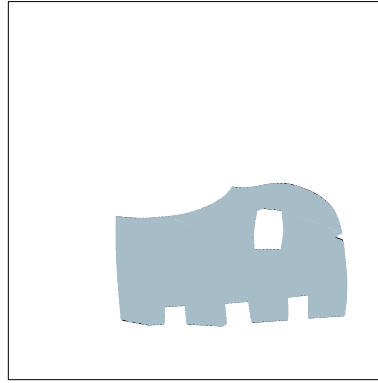

Color: 2
Stop: 2
Element:
Code: 1076
Name: Nautical Blue
Chart: Hemingworth PolySelect
Stitches: 3,674
Thread used: 23.43m

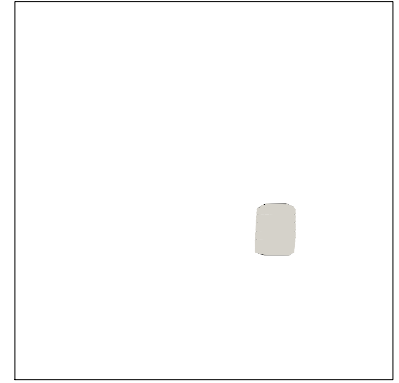

Color: 3
Stop: 3
Element:
Code: 1118
Name: Marshmallow
Chart: Hemingworth PolySelect
Stitches: 351
Thread used: 1.97m

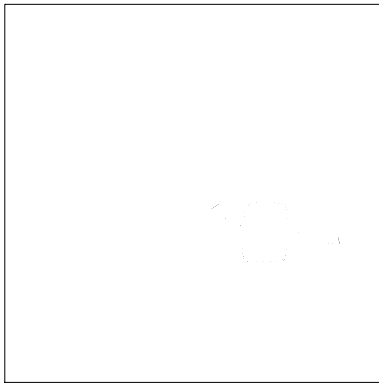

Color: 4
Stop: 4
Element:
Code: 1001
Name: Pure White
Chart: Hemingworth PolySelect
Stitches: 475
Thread used: 2.47m

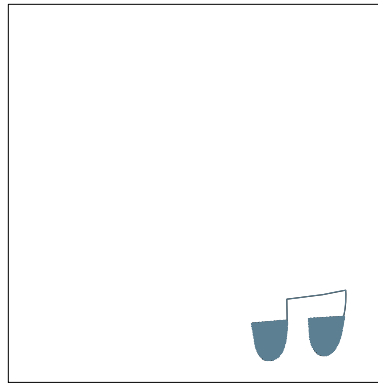

Color: 5
Stop: 5
Element:
Code: 1075
Name: Misty Blue Gray
Chart: Hemingworth PolySelect
Stitches: 523
Thread used: 2.65m

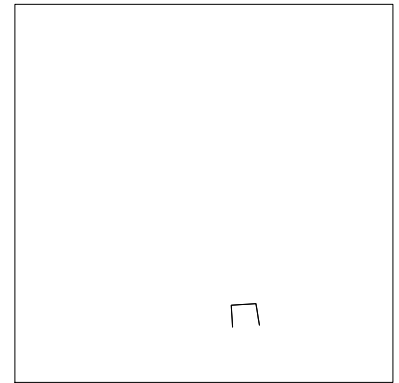

Color: 1
Stop: 6
Element:
Code: 1000
Name: Classic Black
Chart: Hemingworth PolySelect
Stitches: 11
Thread used: 0.05m

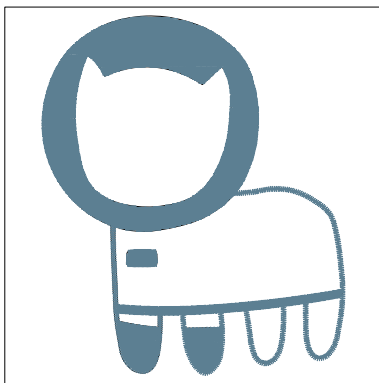

Color: 5
Stop: 7
Element:
Code: 1075
Name: Misty Blue Gray
Chart: Hemingworth PolySelect
Stitches: 5,201
Thread used: 28.42m

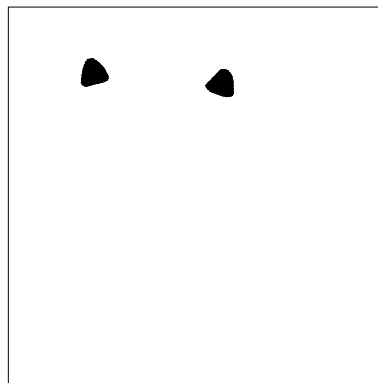

Color: 1
Stop: 8
Element:
Code: 1000
Name: Classic Black
Chart: Hemingworth PolySelect
Stitches: 294
Thread used: 1.36m

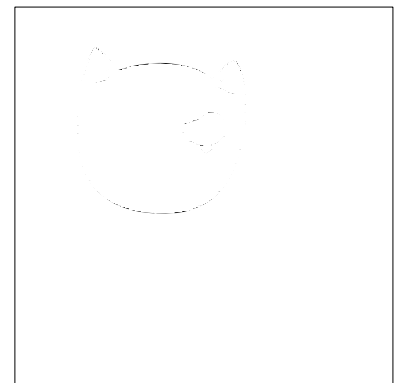

Color: 4
Stop: 9
Element:
Code: 1001
Name: Pure White
Chart: Hemingworth PolySelect
Stitches: 3,051
Thread used: 19.46m

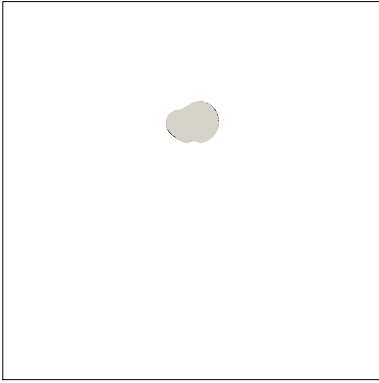

Color: 3
Stop: 10
Element:
Code: 1118
Name: Marshmallow
Chart: Hemingworth PolySelect
Stitches: 330
Thread used: 1.78m

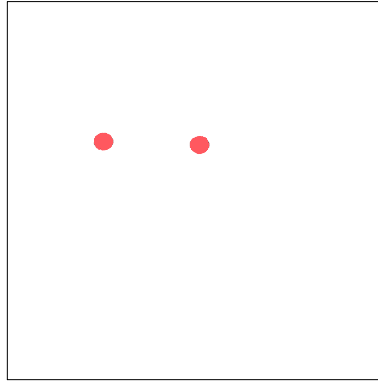

Color: 6
Stop: 11
Element:
Code: 1278
Name: Rebel Peach
Chart: Hemingworth PolySelect
Stitches: 96
Thread used: 0.56m

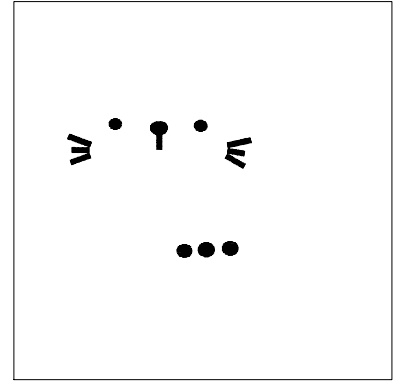

Color: 1
Stop: 12
Element:
Code: 1000
Name: Classic Black
Chart: Hemingworth PolySelect
Stitches: 526
Thread used: 2.27m

Design:Space 09.EMB

Height: 95.4 mm
Width: 78.8 mm
Stitches: 12,669
Colors: 5
Color changes: 5
Trims: 26
Hoop: No hoop
Total bobbin: 27.46m

Color Sequence:

#	Color	Code	Name	Chart
1.	1	1077	Antique Silver	Hemingworth PolySelect
2.	2	1118	Marshmallow	Hemingworth PolySelect
3.	1	1077	Antique Silver	Hemingworth PolySelect
4.	3	1018	Dark Salmon	Hemingworth PolySelect
5.	4	1000	Classic Black	Hemingworth PolySelect
6.	5	1001	Pure White	Hemingworth PolySelect

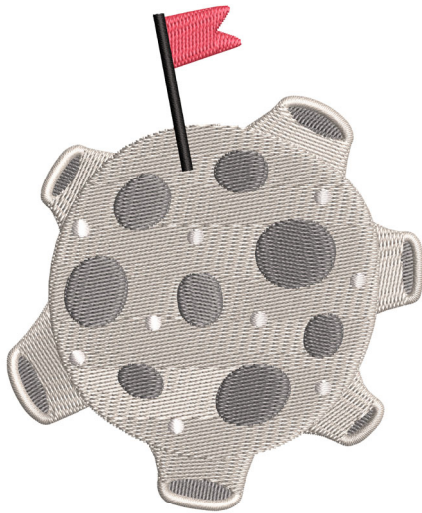

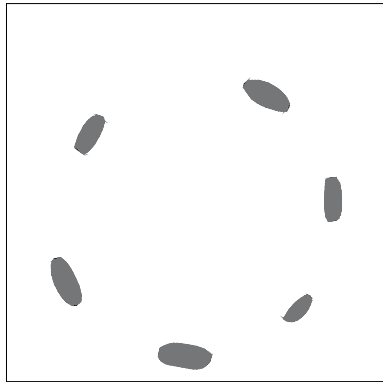

Color: 1
Stop: 1
Element:
Code: 1077
Name: Antique Silver
Chart: Hemingworth PolySelect
Stitches: 1,229
Thread used: 5.74m

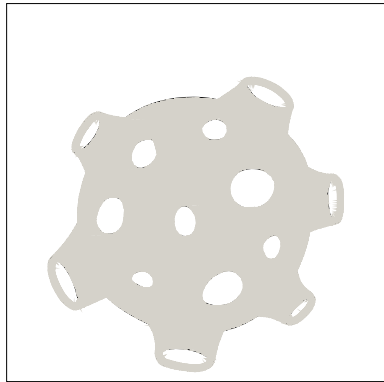

Color: 2
Stop: 2
Element:
Code: 1118
Name: Marshmallow
Chart: Hemingworth PolySelect
Stitches: 8,523
Thread used: 50.91m

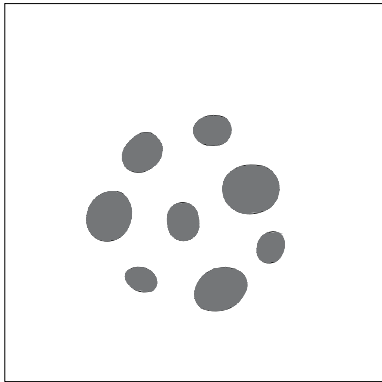

Color: 1
Stop: 3
Element:
Code: 1077
Name: Antique Silver
Chart: Hemingworth PolySelect
Stitches: 2,069
Thread used: 10.98m

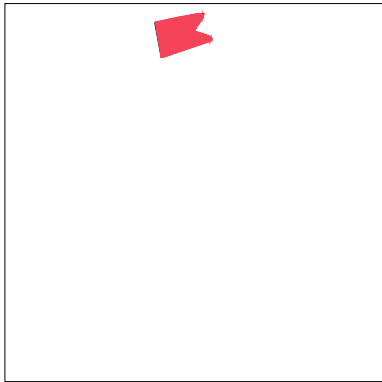

Color: 3
Stop: 4
Element:
Code: 1018
Name: Dark Salmon
Chart: Hemingworth PolySelect
Stitches: 346
Thread used: 1.77m

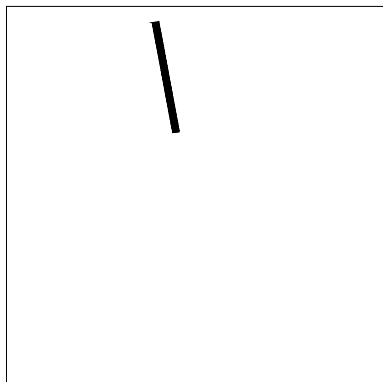

Color: 4
Stop: 5
Element:
Code: 1000
Name: Classic Black
Chart: Hemingworth PolySelect
Stitches: 209
Thread used: 0.98m

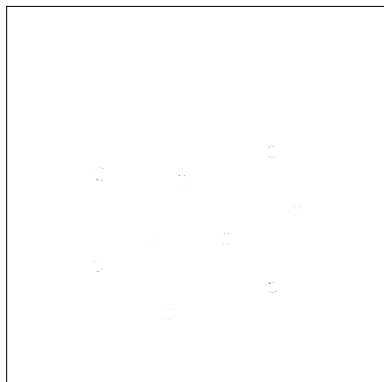

Color: 5
Stop: 6
Element:
Code: 1001
Name: Pure White
Chart: Hemingworth PolySelect
Stitches: 293
Thread used: 1.29m

Design:Space 10.EMB

Height: 94.2 mm
Width: 95.3 mm
Stitches: 13,725
Colors: 7
Color changes: 6
Trims: 16
Hoop: Hoop SQ14 (140 x 140)
Total bobbin: 34.39m

Color Sequence:

#	Color	Code	Name	Chart
1.	1	1118	Marshmallow	Hemingworth PolySelect
2.	2	1075	Misty Blue Gray	Hemingworth PolySelect
3.	3	1076	Nautical Blue	Hemingworth PolySelect
4.	4	1077	Antique Silver	Hemingworth PolySelect
5.	5	1001	Pure White	Hemingworth PolySelect
6.	6	1000	Classic Black	Hemingworth PolySelect
7.	7	1018	Dark Salmon	Hemingworth PolySelect

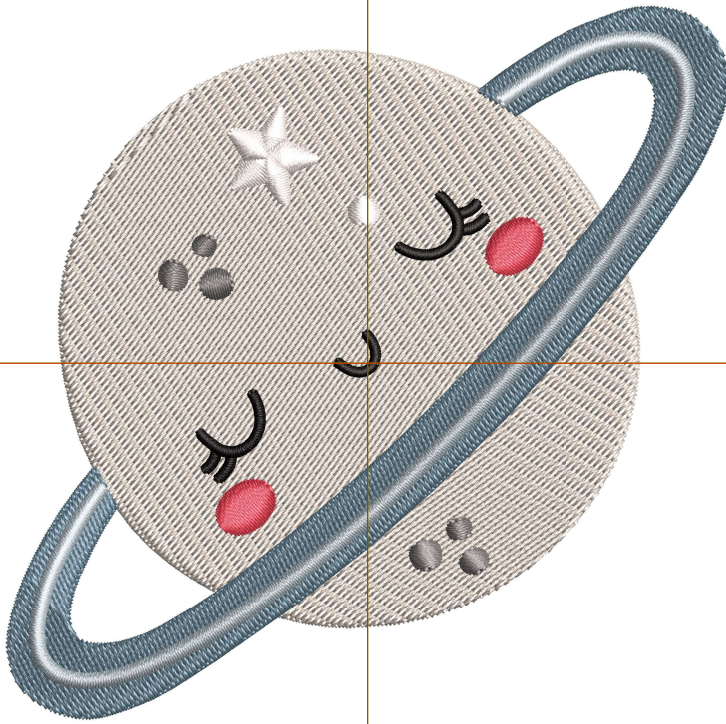

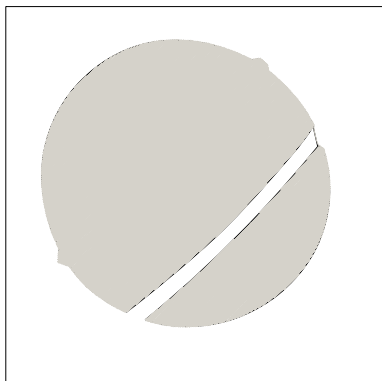

Color: 1
Stop: 1
Element:
Code: 1118
Name: Marshmallow
Chart: Hemingworth PolySelect
Stitches: 7,717
Thread used: 53.40m

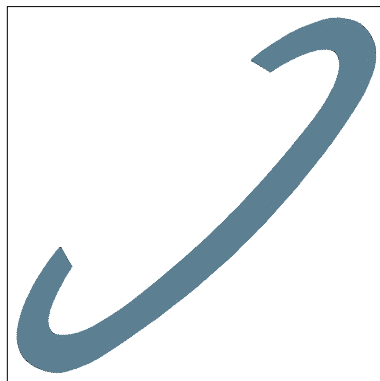

Color: 2
Stop: 2
Element:
Code: 1075
Name: Misty Blue Gray
Chart: Hemingworth PolySelect
Stitches: 3,530
Thread used: 20.06m

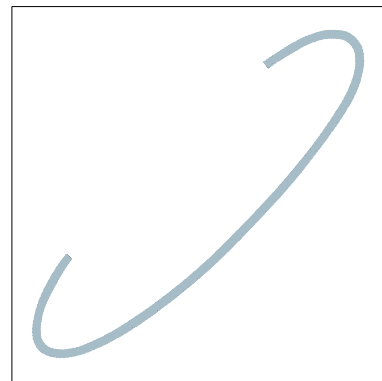

Color: 3
Stop: 3
Element:
Code: 1076
Name: Nautical Blue
Chart: Hemingworth PolySelect
Stitches: 1,233
Thread used: 6.02m

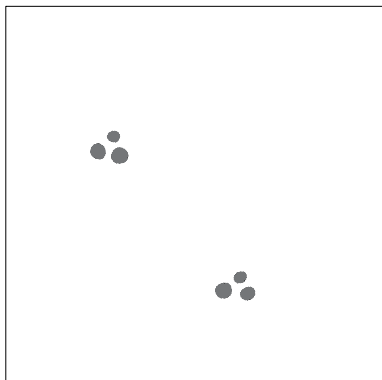

Color: 4
Stop: 4
Element:
Code: 1077
Name: Antique Silver
Chart: Hemingworth PolySelect
Stitches: 237
Thread used: 1.15m

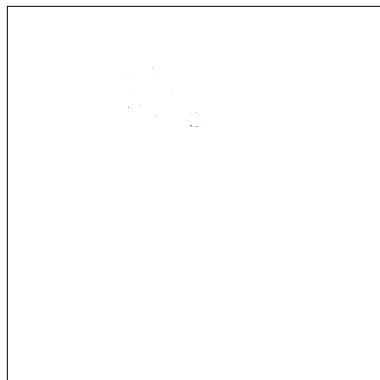

Color: 5
Stop: 5
Element:
Code: 1001
Name: Pure White
Chart: Hemingworth PolySelect
Stitches: 305
Thread used: 1.58m

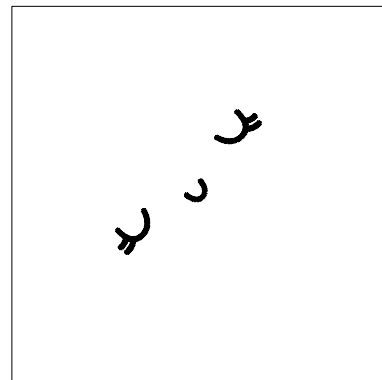

Color: 6
Stop: 6
Element:
Code: 1000
Name: Classic Black
Chart: Hemingworth PolySelect
Stitches: 482
Thread used: 1.84m

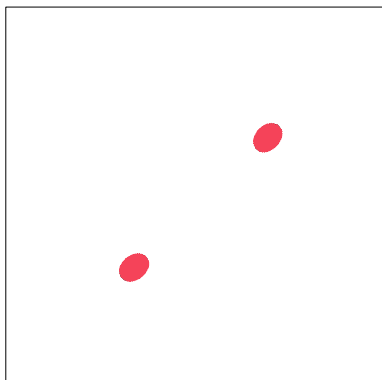

Color: 7
Stop: 7
Element:
Code: 1018
Name: Dark Salmon
Chart: Hemingworth PolySelect
Stitches: 221
Thread used: 1.43m

Design:Space 11.EMB

Height: 95.1 mm
Width: 55.5 mm
Stitches: 8,841
Colors: 6
Color changes: 5
Trims: 18
Hoop: Hoop SQ14 (140 x 140)
Total bobbin: 18.79m

Color Sequence:

#	Color	Code	Name	Chart
1.	1	1023	Marigold	Hemingworth PolySelect
2.	2	1021	Whipped Papaya	Hemingworth PolySelect
3.	3	1075	Misty Blue Gray	Hemingworth PolySelect
4.	4	1076	Nautical Blue	Hemingworth PolySelect
5.	5	1001	Pure White	Hemingworth PolySelect
6.	6	1000	Classic Black	Hemingworth PolySelect

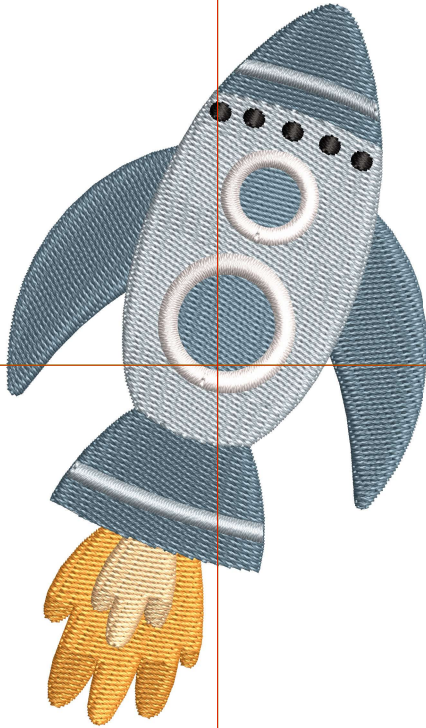

S

E

E

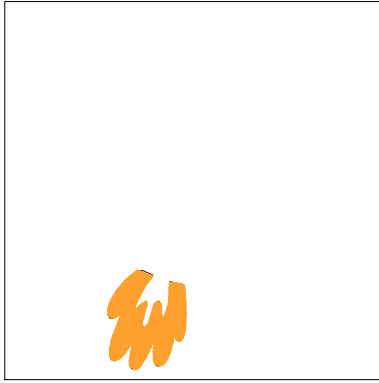

Color: 1
Stop: 1
Element:
Code: 1023
Name: Marigold
Chart: Hemingworth PolySelect
Stitches: 1,209
Thread used: 5.91m

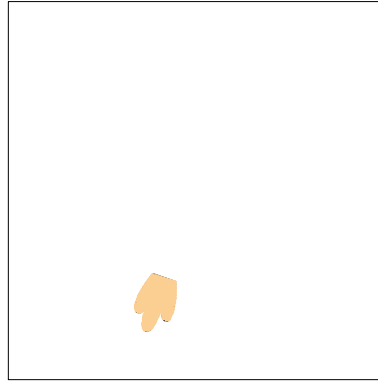

Color: 2
Stop: 2
Element:
Code: 1021
Name: Whipped Papaya
Chart: Hemingworth PolySelect
Stitches: 401
Thread used: 1.95m

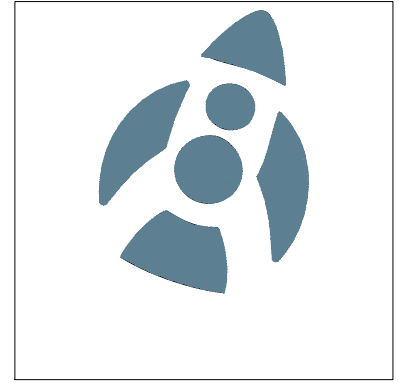

Color: 3
Stop: 3
Element:
Code: 1075
Name: Misty Blue Gray
Chart: Hemingworth PolySelect
Stitches: 3,991
Thread used: 23.33m

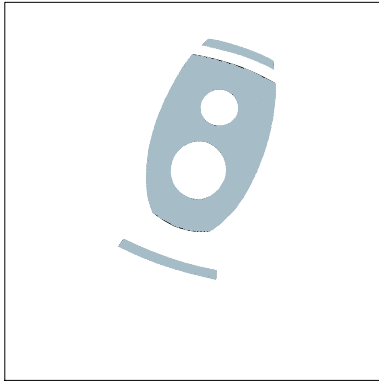

Color: 4
Stop: 4
Element:
Code: 1076
Name: Nautical Blue
Chart: Hemingworth PolySelect
Stitches: 2,505
Thread used: 14.52m

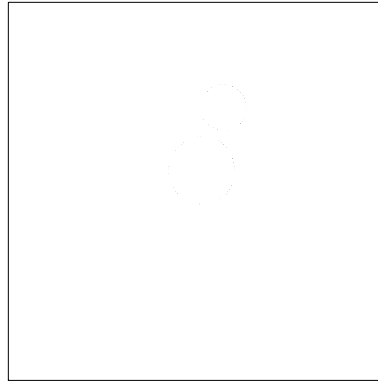

Color: 5
Stop: 5
Element:
Code: 1001
Name: Pure White
Chart: Hemingworth PolySelect
Stitches: 582
Thread used: 3.06m

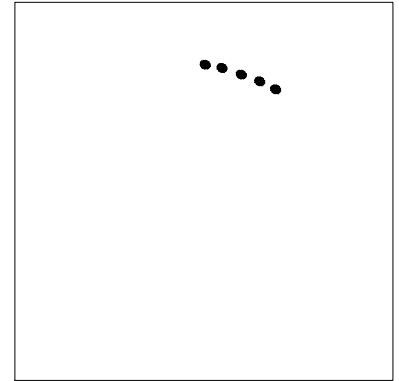

Color: 6
Stop: 6
Element:
Code: 1000
Name: Classic Black
Chart: Hemingworth PolySelect
Stitches: 153
Thread used: 0.61m